

**SAXOPRINT** 

# Artwork guide

Issue Date: May 2024

## Table of contents



Checklist	3	Postcards	14
Cropping area/bleed difference	4	Orientation of the front and back side	15
Resolution	5	Perforations	16
Colours	6	Saving print-ready data	17
Fonts	7	Save PDF file	17
Orthography and composition	8	Standard artwork check	18
Lines	8	Superior artwork check	19
Brochures	9	Online Designer	20
Folded leaflets	12		

## Checklist



- ✓ Is the document laid out in CMYK? With spot colours?
- ✓ Does the file contain any multimedia content, comments or form fields in the print layout such as a clipping path (Photoshop)?
- ✓ Is the file laid out in open end size, with the additional 2 mm bleed allowance?
- ✓ Is the content, that may not be cut off, placed far enough from the edge (min. 3 mm, with calendars, notepads and brochures with spiral binding at least 20 mm on the side where they will be bound)?
- ✓ Does the side number of the document match the side number given in the order? (Have all superfluous sides been deleted? Are all sides clearly marked?)
- ✓ Is the file format correct? PDF (preferably PDF/X4), JPG, TIFF.
- ✓ Are the fonts embedded or converted into strings or curves?
- ✓ Is the image resolution sufficient (at least 250 dpi, line art 1,200 dpi)?
- ✓ Are the lines thick enough? Could any thin lines that would become visible through automatic scaling be hiding in the file?
- ✓ Have all auxiliary lines and layers been deleted?
- ✓ Is everything written correctly (Attention: transposed digits) and legible (font size, contrast)?

Everything checked off?

Then you can send your artwork to us now.

Should you be unsure whether everything is in order, you find helpful tips and tricks on the following pages.

Furthermore you have the possibility to select our superior artwork check when placing your order. Have fun with your finished, printed product.

Your team at [www.saxoprint.co.uk](http://www.saxoprint.co.uk)!

## Cropping area/bleed difference



### OPEN END SIZE

When you completely open your end product, you see what we consider an open end size.

Always lay out your documents in the open end size, including the all-around 2 mm bleed difference that prevents important information from being cut off.

### CLOSED END SIZE

We consider the size that you can see and measure when you have your end product in hand a closed end size. It is also the size that you can choose during the ordering process.

- 1 mm for Envelopes
- 3 mm for Advertising Technology Products, Packaging, Presentation Folders, Fan Clappers and Monthly Calendars
- 15 mm for Textile stretcher frames

**i** Use our free templates to create your documents <http://www.saxoprint.co.uk/print-templates>.

Text and images should be at least 3 mm from the edge of the final format. In the case of calendars, notepads and brochures with spiral binding, please make sure you leave 20 mm space to the edge of the side where they will be bound.

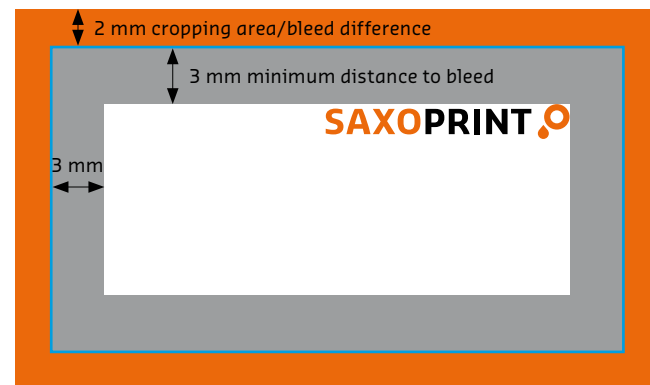

- Bleed
- Safety area
- Information area
- Final format

Position background graphics and images which are supposed to reach the edge of the print product within the cropping area. Like that you can avoid white gaps.

**i** Keep shingling in mind when placing images and texts in brochures (safety distance to the bleed). If you have not ordered a superior artwork check, sizes that differ from the information on your order will automatically be scaled to the ordered size (without bleed difference).

## Resolution



We recommend a graphic resolution of at least 250 dpi for grey scale and colour graphics (in the original size) to ensure an optimal printed result. Please consider a difference in resolution for the following products:

- resolution of at least 150 dpi – Ad Posters, Advertising Technology Products with text
- resolution of at least 72 dpi – Advertising Technology Products

**i Please save advertising technology products that are designed on a scale of 1:10 in a resolution of at least 1,500 dpi.**

Line art (e.g. text with a small point size and symbols) should be laid out with a resolution of 1,200 dpi to avoid a “saw

tooth” effect. This occurs because line art, in contrast to other images with fluid transitions, shows hard colour edges and high contrast.

**i Always lay out your graphics with the right size and resolution. Scaling up or increasing the resolution later on will result in poorer quality.**

The higher the resolution, the greater the amount of data. To reduce this amount, we recommend that you cut your images down to the size or detail you would like to use (Fig. 1).



Fig. 1: Cropping the image to reduce the size of the file

# Colours



## SPOT COLOURS

Spot colours are pre-defined, full tone colours and defined basic tones, i.e. colour nuances whose advantage is that they are mixed separately and can therefore be applied in printing as individual colours. That means they will always be mixed in exactly the same proportions, which assures that the colours will always remain the same, offering the best possible colour fidelity and reproducibility.

There are various providers of so called spot colours:

- Pantone (Hexachrome)
- HKS
- RAL

At SAXOPRINT, we use HKS and Pantone colours. For more information visit: <https://www.saxoprint.co.uk/spotcolours>.

**ⓘ HKS spot colours can be converted into CMYK colours. When converting HKS to CMYK colour deviations may occur.**

## COLOUR LAYOUT AND COLOUR MODE

Lay out your documents in grey scale, CMYK or with spot/special colours, not with RGB!

Lay out HKS spot/special colours as such, and please give the colour names correctly in order to avoid distortion of your desired colours.

HKS K or Pantone C for art paper/printing paper

HKS N or Pantone U for unbleached/uncoated paper

Before saving, rid the document of all superfluous colours (for example, from your colour or mixing palette), so that only the colours you truly chose are used in printing. Do not lay out pre-separated files! That means you are not to split your files into four different levels (one for each of the colours, cyan, magenta, yellow, and key = black).

We recommend to set up grey areas in graduations of black only in order achieve a satisfying printing result. Creating grey areas using the 4 process colours CMYK it could lead to colour variations.

**ⓘ Printing machines print four colours in CMYK. RGB is predominantly suited for the display of colours on a screen.**

## Fonts



Do not place text, logos and other elements too close to the edge of the page, otherwise they may be cut off. We recommend a distance of ca. 3 mm from the edge of the page. see page 4 „cropping area/bleed difference“.

The font size should be at least 6 pt to ensure readability. Please keep in mind that the general reading font size is 12 pt. The larger your product, the larger the optimal font size should be. That means, for example, that 6 pt, while a reasonable size on a business card, would be essentially unreadable on a poster or flyer.

Fonts must be embedded in the document or converted into curves to avoid problems with the text size. You may not use mixed colors (CMYK) for designing black texts, but 100% black (K-channel).

**i** There are standard fonts that are installed on most PCs. There are also, however, typical fonts for a particular programme that are not installed on every computer and therefore cannot be displayed, or will be converted to a standard font. To avoid this, fonts have to be embedded.

**i** Please avoid fonts like „Kalinga“, „Amatic“, „Amatica“ and „Kartiga“ because they can lead to errors in printed images. If they cannot be avoided, be sure to convert the font into paths and curves.

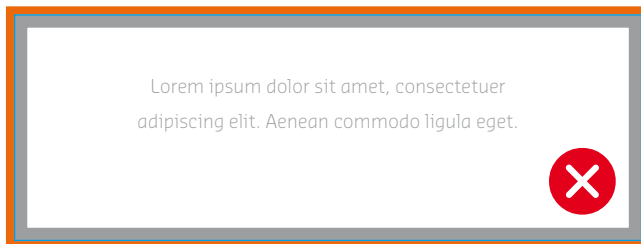

Due to its brightness/lightness, the font does not differentiate itself significantly from the background

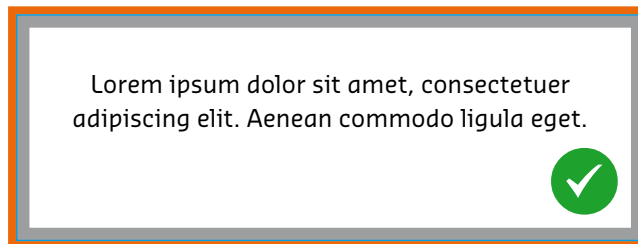

The font size is always to be adjusted for the final product so that it ensures readability

## Orthography and composition



We do not control your document in terms of content. For multi-side documents, or documents with folds, make sure that the alignment and the sequence of the sides are clearly recognisable.



Outside



Inside

## Lines

Do not use hairlines. Lines should be at least 0.125 pt thick with an ink application of at least 40%.

We recommend not to use frames that shall act as border for the whole document (end size) as these may be cut due to the customary cutting tolerance.

**i** Lines that are laid out with an insufficient thickness will be automatically thickened by our editing programme. Please make sure that no lines of 0 pt thickness are hiding in your document, because they may appear in the final product as a result of the automatic thickening.



# Brochures



## SHINGLING

When folding many sheets of paper at once, the most inside pages are pushed out. This is called shingling. When cutting the brochure to one single length in the following, the inner sides are therefore shorter by the shingling difference. To avoid that elements placed directly on the edge (e.g. page numbers, lines etc.) are cut off you should keep in mind the shingling when creating your artwork.

In order to avoid trimming objects close to the edges, such as page numbers, lines and other elements, we apply a minimal anamorphic (unproportional) scaling to your data. For this purpose, please maintain a minimum distance of 5 mm from the paper edge.

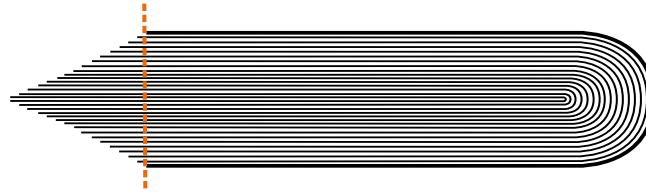

Schematic model of shingling

# Brochures

## Staple, loop and spiral binding



### INSIDE PAGES AND COVER

Please create brochures as consecutive, individual sides starting with the cover page (Fig. 1). Please transfer these individual pages to us in a multi-page PDF document.

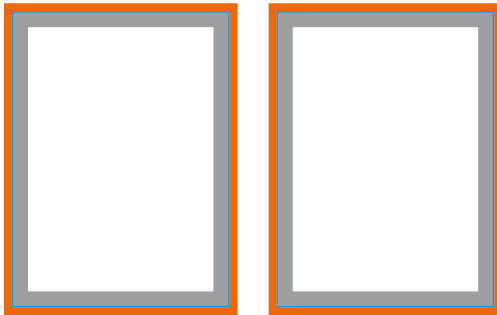

Fig. 1: Separate pages for inside pages and cover

### FOLDED COVER (FOR STAPLE AND LOOP BINDING)

For brochures with folded cover the side next to the folded in side has to be 2 mm shorter and the side that will be folded in 4 mm shorter (Fig. 2).

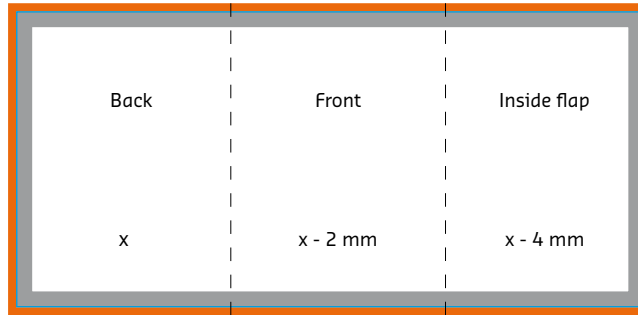
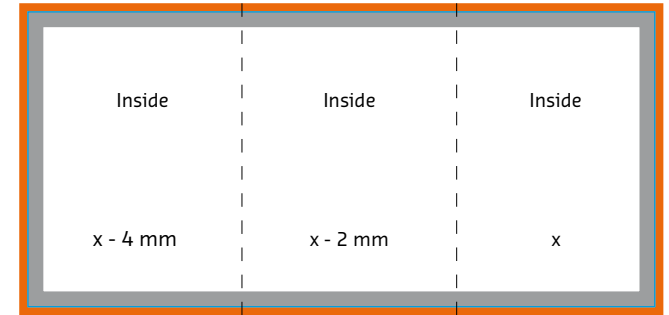

Fig. 2: Pre-assembled pages for folded cover



**i** Please do not forget to delete empty or superfluous pages from the file before your final save. Desired blank pages have to stay in the file.

**i** When transmitting individual sides, please include the side no. in the file name. A sorting based on the side numbers in the file will not be done.

# Brochures

## Perfect binding



### CONTENT

Please apply all pages as continuing separated pages (Fig. 1). The very first side as well as the last side of content will be pasted about 5 mm onto the cover inside to make it long-living. Keep in mind that therefore 5 mm visible design space will disappear.

**i** We recommend a safety margin of 10 mm to the fold.

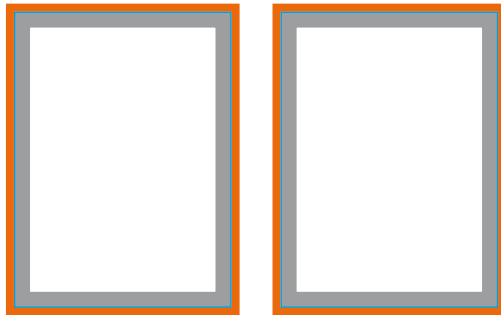

Fig. 1: Separate pages for inside contents

### COVER AND FOLDED COVER (FOR PERFECT BINDING)

The cover has to be completely set up and attached with the spine (Fig. 2). The width of the spine depends on the number of sides and may vary. Please find further information on creating artwork, as well as tables for all book spine sizes in our data sheets: <http://www.saxoprint.co.uk/print-templates>.

**i** If you chose a folded cover the side next to the folded in side has to be 2 mm shorter and the side that will be folded in 18 mm shorter (Fig. 3)!

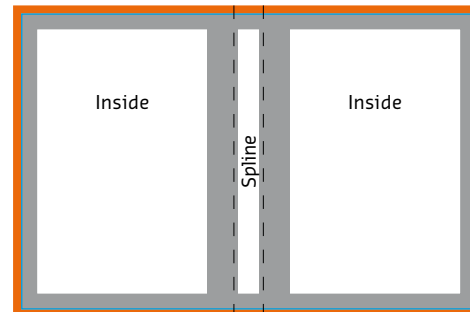
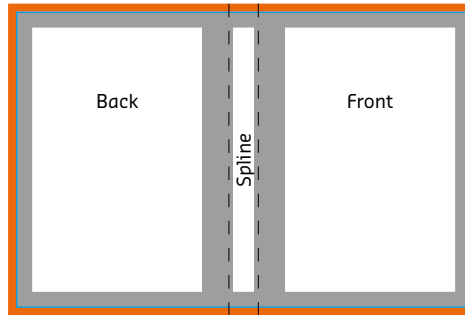

Fig. 2: Pre-assembled pages for cover

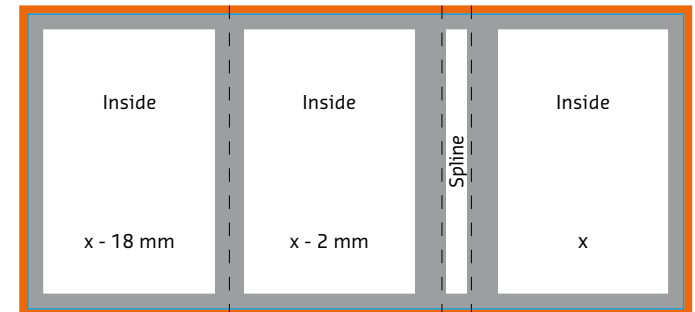
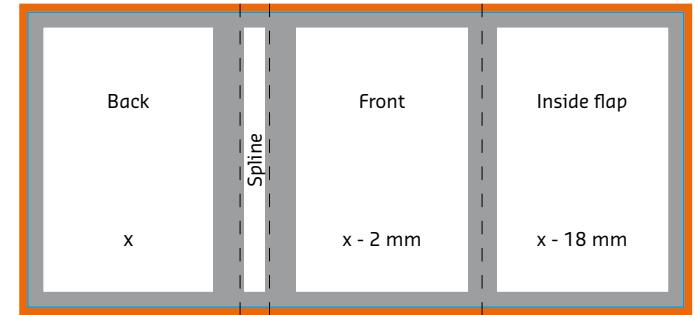

Fig. 3: Pre-assembled pages for folded cover

## Folded Leaflets

### 4 sided folded leaflet (single fold)

For folded leaflets, the adjacent sides should be created on one page – meaning pre-assembled. Please note: for different page orientations on the front and back of the pages inside a printed product printed on both sides that the product will turn 180° on the vertical axis.

The layout and the orientation of the format must be created accordingly.

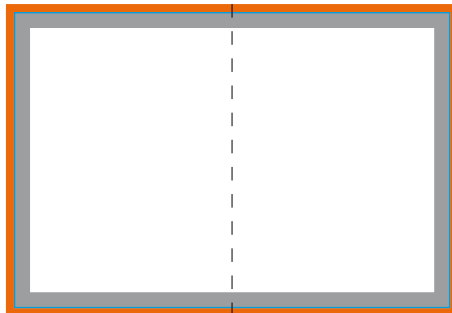
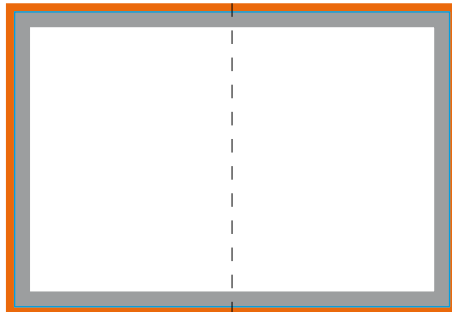

Pre-assembled sides for folded leaflet

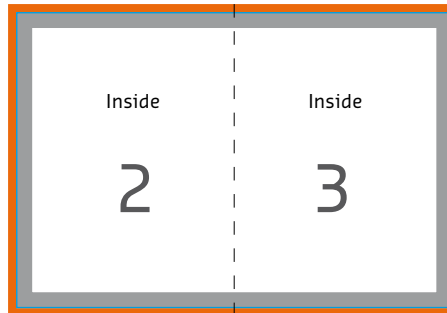
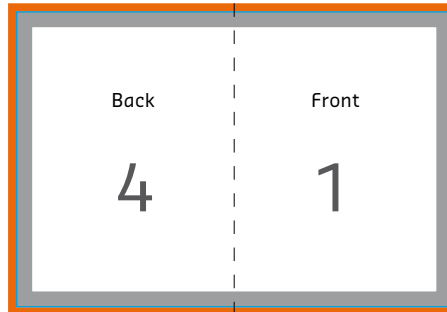

Orientation for portrait brochure

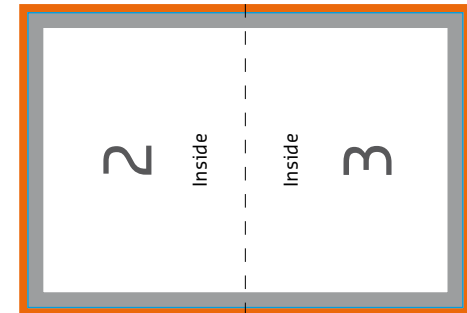
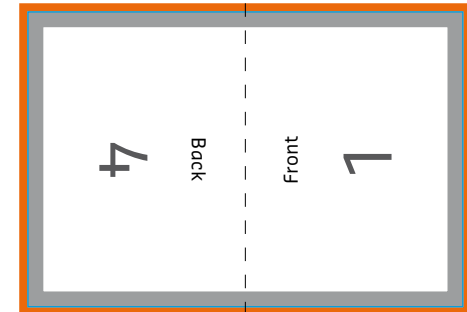

Orientation for landscape brochure



# Folded Leaflets

## 6 sided folded leaflet (letterfold)

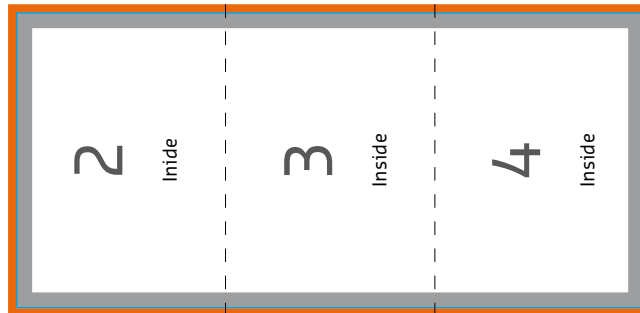
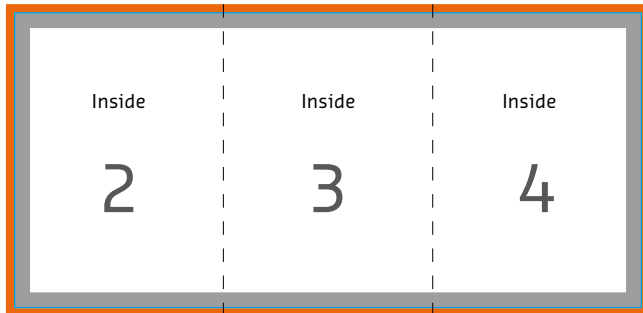
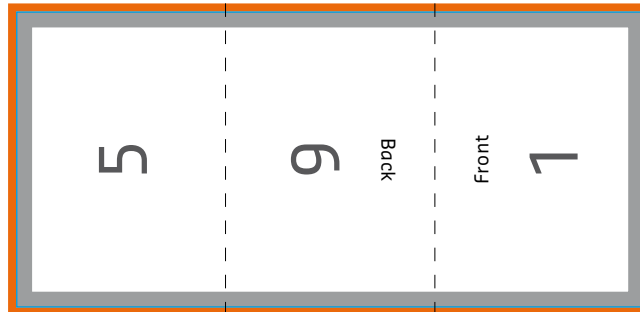
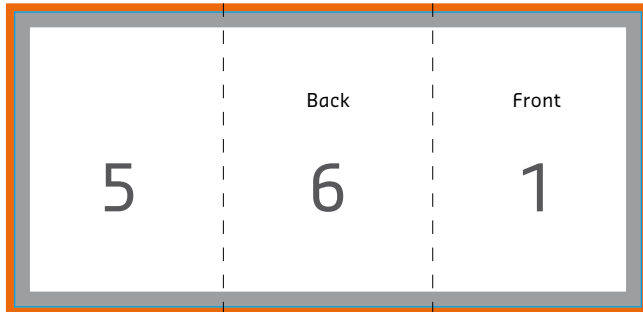

Orientation for portrait brochure

Orientation for landscape brochure

## Postcards

Postcards can be laid out in portrait or landscape format, though the rear side should always be in landscape format in order to conform to normal reading habits and to avoid problems with the post.

Please create both sides separately and pay attention to the orientation and the correct name. That means you should lay out the front so that one can read the text “normally” (so that the bottom edge is at the bottom of the image). Please name the front as obverse and the rear as address side. The accompanying picture shows you how front and back are arranged by default by our prepress.

**❗ Note:** You can find a suitable template for the back side of your postcard here:  
<https://www.saxoprint.co.uk/print-templates>.

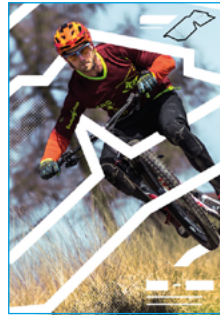

Front

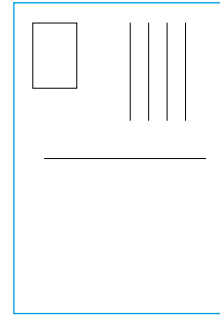

Back

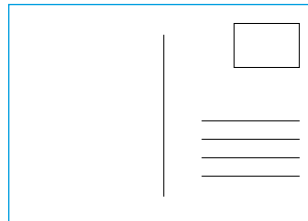

Back



# Orientation of the front and back side

Please note that for multi-page print products, the front and back sides are rotated on the side (left or right) of the respective format. (Landscape: short side and portrait: long side). Printing is based on the page orientation of the artwork sent to us. Please note that artwork is printed in accordance with your order.

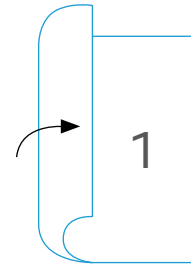
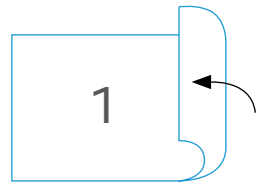

Orientation: for landscape, short side

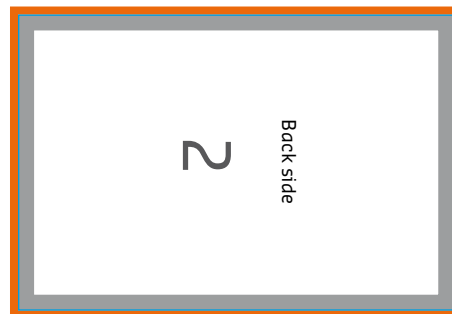
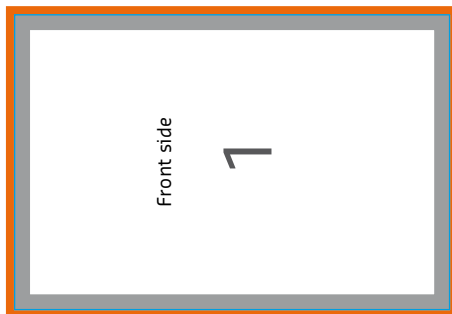

Orientation: artwork rotated 90° for landscape, short side

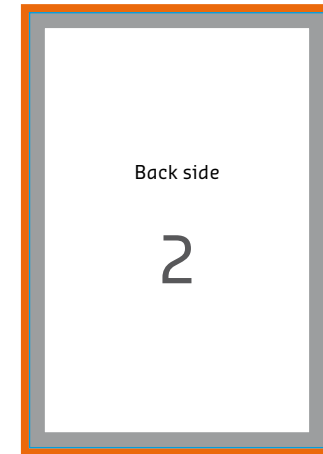
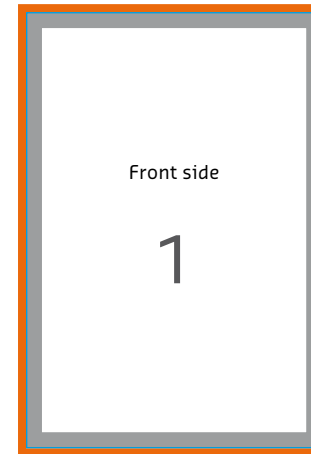

Orientation: portrait, long side

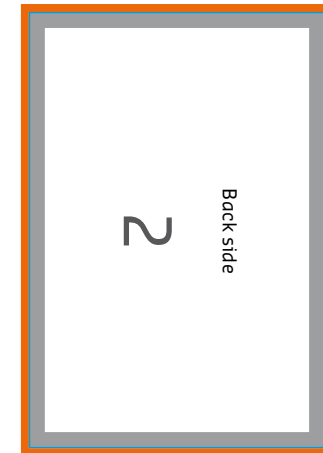
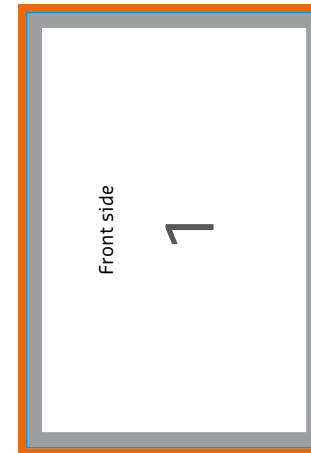

Orientation: artwork rotated 90° for portrait, long side

# Perforations



## BROCHURE WITH COVER

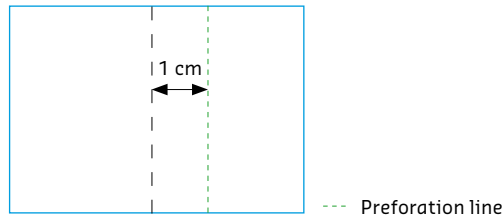

- at least 1 cm away from the fold not in the spine
- 1 perforation line for 4-sided cover
- max. 2 perforation lines for folded covers
- perforation lines parallel to spine/fold
- no perforation if the grammage is less than 90gsm

Perforations serve to make the separation of parts of your product easier. They are useful when contact information or other important data ought also to be available separate from the actual mean of communication (i.e. printed product).

For the various formats of your printed product, there are a few basic things to keep in mind regarding perforation (see description above). When saving, be sure there are no auxiliary lines left that mark the perforation lines but should

## FLYERS

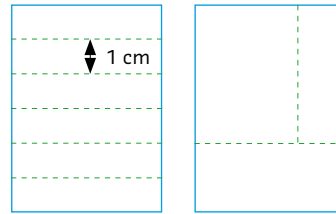

- at least 1 cm away from the edge
- the minimum distance between two should be 1 cm
- max. 6 perforation lines parallel to each other
- max. 1 orthogonal (right-angled) perforation line

not be printed themselves. To position the perforations, we only need one reference template. It is best if you mark the lines and save that picture as a separate file that you have named accordingly (e.g. ordernumber\_perforation template.jpg). You can place up to 6 perforation lines for your print products. These have to run parallel to each other. For 1-sided and 2-sided print products up to one perforation can run orthogonal (right-angled), but this one does not have to run completely through the page.

## FOLDED LEAFLETS

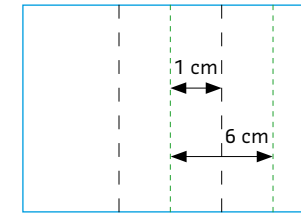

- at least 1 cm away from the fold or lying in the fold/break
- max. 3 perforation lines
- perforation lines parallel to fold
- minimum distance between perforation lines: 6 cm

**i** Be sure not to lay out auxiliary lines that mark the perforation lines but should not be printed themselves. We only require one template on which it is clear where the perforations should be placed.

**i** Because of the corresponding paper strength, perforations are only possible on papers with grammages of more than 80gsm. Please pay attention to the requirements you select about such products.



# Saving print-ready artwork



## FILE FORMATS

Please only use closed, read-only formats to save your print data:

- PDF, JPEG, TIFF

**i** WORD, EXCEL and PowerPoint do not create print-ready artwork.

**i** In CoreIDRAW created PDFs may show incorrect colour representations. Please create only JPEG files with CoreIDRAW.

**i** When converting TIFFs to PDF files, please make sure the file has:

- Reduced background layer
- 8-bits per channel (32-bits in total)
- No alpha channel
- No transparency path
- No multi-page TIFFs
- A maximum of 300 dpi resolution

## STANDARDS

In menu item „file“ you can save or export the file. Depending on the programme further windows will open with which colour mode, quality and resolution can be set:

- Colour mode: CMYK
- Resolution: 250 dpi (product-specific)
- Quality: maximal
- Colour profile: PSO Coated v3 – FOGRA51  
for coated paper  
PSO Uncoated v3 – FOGRA52  
for uncoated paper

**i** Multimedia content, comments or form fields and clipping paths (Photoshop) are not permitted.

Please refer back to the information on the previous pages.

## FILE NAMING

Please name your file uniquely (job number, page order for single pages), e.g.:

- AU123456-Brochure-p1, AU123456-Brochure-p2, ...

Please do not use any special or space characters.

## FILE SIZE

The maximum data volume of your print files has to be less than 1 GB per order. Please edit the pictures or the resolution, taking the minimum standards into account.

A summary of the your data as ZIP or RAR file can be easily accessed.

## Save PDF file

Files in PDF-Format are both for you and us the most secure way to produce a high-quality printed product, because this format has been especially developed for the exchange of data between two professional prepress organisations. The free Acrobat Reader programme is not sufficient for the creation of printable PDF files. For this, the Acrobat Full Version is available, although it does cost. You can also

use the capabilities of your layout programme, as long as you pay attention to a few adjustments that will facilitate the creation of a perfect PDF file. When creating a PDF file directly from the layout programme, please use the PDF/XStandard (PDF/X-4, compatible with PDF 1.6). Make sure all colours are converted to CMYK. Convert spot colours as specified in the order information and avoid multiple

layers – even if they are PDF/X-4 compatible. Colour space conversion should be done before a transparency reduction. Therefore, preserve the native transparencies in the PDF. This applies in particular to programs that do not support PDF/X standards when creating PDF files.

## Standard artwork check



Our standard artwork check is always included and the following will be checked:

- correct and closed file format of your artwork (PDF, JPG, TIFF)
- number of sides
- correct size

**i** We will scale your artwork automatically to the desired size (without bleeding) if the provided size is incorrect (only if possible/proportional). Please note that adjustments to the size, especially when scaling up the artwork (e.g. A6 ▶ A4) can cause a decrease in the resolution and furthermore no bleeding will be added.

- pre-assembled artwork if you have ordered folded leaflets with more than 4 sides (correct order)
- clear binding if you have ordered brochures
- perforation lines indicated and possible
- Artwork provided as greyscale if you have ordered one colour printing (black) – if it is not provided 1-coloured (greyscale) it will be transformed correspondingly. This may lead to colour deviations.

- HKS spot colours have been laid out and named correctly (if HKS or Pantone ordered)
- automatic conversion into CMYK if artwork was created in RGB or spot colours

**i** Please note that the automatic conversion of RGB into CMYK can cause colour differences.

- fonts embedded

Our customer service will contact you immediately by email if your artwork present any of the problems mentioned above. Please note that conversions of size and colour mode as well as spot colours will be processed automatically and there will be no information (if no HKS or Pantone is ordered).

## Superior artwork check



Use our “Superior Artwork Check” if you are uncertain whether your artwork meets all our requirements and if a high quality product can be provided. For a small additional fee, the professional pre-press staff will carry out a review of your artwork files on the basis of the following checklist in addition to the standard artwork check:

- any layers in the artwork (PDF files)
- artwork provided in the correct size
- bleed of 2 mm
  - correct type and position of fold if folded leaflets were ordered (gate fold, letterfold, z-fold, landscape or portrait)
- enough space between letters/graphic elements and the bleed (at least 3 mm)
  - correct colour mode in CMYK
  - colour profile check (PDF files)
- **Our customer service will get in contact with you if your artwork files are not created in CMYK. At your express request we can convert your artwork into CMYK, however this may result in colour deviations.**
- sufficient image resolution (at least 250 dpi, posters 150 dpi, line art 1,200 dpi)

If your artwork presents any of the problems mentioned above our customer service will contact you immediately by email. Please note that no automatic conversions/adjustments will be made. Please also note that we will not check if the side sequence of your artwork is correct.

## Online Designer

Create your printed products easily online with our SAXOPRINT Designer. We will explain how to use it step by step. If you have any further questions our customer service team will be happy to help you.



### 1 Choose Product

You can use the designer for many of our printed products, like flyers, folded leaflets, packaging or notepads.



### 2 Configure Product

Set the specifications for your product to fit your needs. Then, click the button „Design online“ on the right hand side.



### 3 Create your Design

Paste your text, pictures and artwork and edit the colour, font and size. You can also upload PDF documents.



### 4 Confirm and save or place order

After you finish your design, you have the opportunity to check it over and then order your product. Alternatively, you can save your product. Then you can easily retrieve it in our customer area anytime to continue working.



[www.saxoprint.co.uk/designer](http://www.saxoprint.co.uk/designer)